

Operating Instructions Testomat[®] Modul TH-R

Measuring converter
for residual total hardness
(water hardness)
parameterisable via RS232



Content

Content	2
Important safety information	4
Intended use	4
Qualification of personnel	4
Warnings in this manual.....	5
Additional documentation.....	5
Special attention is required at this point	5
General Information	5
Requirements for the installation site.....	5
Requirements of cable for operating voltage and system components and installed lines	6
Requirements for cable ducts	6
During assembly	7
During operation	7
During cleaning	8
Repairing a defective device.....	8
During disposal	8
Operating requirements	9
Scope of delivery	10
Performance specifications	10
Interaction with the controller	10
Available indicators	11
Assembly	12
Assembling the Testomat® Modul TH-R	12
Use of the Testomat® Modul TH-R within a pressure range of 0.3 to 1 bar	12
Connecting the water intake and discharge.....	13
Water intake	13
Water drain.....	14
Connect mains and devices.....	14
Block diagram of Testomat® Modul TH-R	15
Connecting inputs and outputs	16
Internal design Testomat® Modul TH-R	17
Commissioning	18
Inserting the indicator bottle.....	18
Opening the water inlet	18
Venting indicator line.....	19
Functions of the operating and display elements	20
Function keys	20
Additional control elements on the circuit board	20
Display elements of the function keys	21
Adjusting parameters in the device	22
Calling up selection mode on the device	22
Starting USB communication	22
Entering parameters via the Service Monitor program	22
Exiting selection mode	22
Start of measurements.....	23
Other functions in selection mode	23
Functions of the SD card	24
Storage of measured values and alarms	24

Functions of the USB connection.....	25
The Service Monitor program	27
Installing the Service Monitor	27
Selecting language	28
Adjusting parameters	28
Example: Changing the interval pause in the Service Monitor for Testomat® Modul TH-R	31
Description of the signal inputs and outputs	32
Control input STOP/START	32
Fault signal output "Alarm"	33
Current output 4-20 mA	33
Calculation of output currents	33
Serial interface	34
Notification format	34
Remote control via RS232 interface	34
The IMPORT command	35
The EXPORT command	35
The command CS_ERR	36
The command SW_RST	36
Formation of the checksum.....	36
Further explanations on programming.....	36
Error messages and troubleshooting	38
Temporary faults	38
Error messages.....	38
Indicator shortage	40
Correct water level in the measuring chamber	41
Maintenance message.....	42
Maintenance	43
Cleaning intervals	43
Service instructions.....	43
Cleaning of the measuring chamber and the sight-glass windows.....	44
Cleaning the filter housing	44
Changing an empty indicator bottle	45
Replacing an indicator bottle without a shortage notification.....	45
Firmware update	46
Firmware update error list.....	46
Optional display for measured value display	48
Testomat® Modul TH-R spare parts and accessories	50
Indicators.....	51
Additional accessories	51
Technical data	52
Conformity Declaration	53

Important safety information



Read the operating instructions carefully and in full before working with the device.

Ensure that the operating instructions are accessible at any time for all users. When an SD card is used in the device, it can also be stored on the same as a PDF file.

If transferring the Testomat® Modul TH-R device to third parties, ensure these operating instructions are always included.

Observe the safety precautions and safety recommendations when using reagents, chemicals and cleaning agents. Observe the relevant safety data sheet! For reagents we supply, the relevant safety data sheets are available online at www.heylanalysis.de.

Intended use

The scope of use of the Testomat® Modul TH-R is the automatic determination and monitoring of the residual total hardness (water hardness) in water. In the process, the required measurement scope is determined based on the selected indicator and corresponding user programming.

Comply with the output limits specified in the [Technical data](#) section on page 52.

Observe the areas and limits of application of the indicators and the requirements imposed by the medium to be measured.

The scope of intended use presumes that you have read and understood the instructions and particularly the section [Important safety information](#).

Improper use is deemed to occur if you use the device

- outside the applicable scope, as specified in these instructions,
- under operating conditions that deviate from the scope specified in these instructions.

Qualification of personnel



The assembly and commissioning require basic electrical and process engineering expertise as well as knowledge of the applicable specialist terms. The assembly and commissioning must therefore be performed only by a specialist or a properly trained person instructed and supervised by a specialist.

A specialist is a person who can draw on professional training, knowledge and experience as well as knowledge of applicable provisions to assess work assigned to him/her, detect potential hazards and implement suitable safety measures. A specialist must comply with the applicable professional rules.

Warnings in this manual

These instructions include warnings against specified actions that involve the risk of injury or property damage. Warnings are structured as follows:



Description of the type or source of danger

Description of the consequences of non-compliance

- Hazard prevention indications. Compliance with these hazard prevention measures is imperative.



The signal word "**RISK**" refers to a significant danger that represents a direct threat and will definitely result in severe injuries or even be fatal if not avoided.



The signal word "**WARNING**" refers to a possible danger that may result in severe injuries or even be fatal if not avoided.

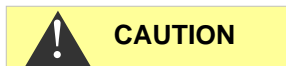

The signal word "**CAUTION**" refers to a potentially dangerous situation that could result in minor to moderate injuries or property damage if not avoided.



The signal word "**NOTE**" refers to important pieces of information. If this information is not heeded, it may adversely affect operational procedures.

Additional documentation

The Testomat® Modul TH-R is a system component. Accordingly, you should also observe the system documentation of the system manufacturer.

Special attention is required at this point

General Information



- During assembly and commissioning, observe the specific national and local requirements.
- Observe the accident prevention and conservation requirements in the country of use and at the installation site.
- Make no changes or modifications to the device that go beyond the scope of use specified in these instructions. Doing so will void the warranty.

Requirements for the installation site

Ensure that the following conditions are met at the installation site:

- Use the device in indoor locations only.
- The ambient temperature is between 10 and 40 °C.
- The installation site is at altitudes under 2000 m.
- The maximum relative humidity is 80 % at temperatures of up to 31 °C (linear declining up to 50 % relative humidity at 40 °C).

- The device must always be protected against wetness and moisture. Under no circumstances may it be exposed to splashed water or condensate.
- Surge category II
- Soiling degree II

Requirements of cable for operating voltage and system components and installed lines

Use only cables and installed lines which meet the following requirements:

- The terminal strips on the circuit board require core cross-sections of between 0.08 and 2.5 mm². This applies to single-wire and fine-wire cores with wire end ferrules without plastic collar.
For fine-wire cores with wire end ferrules and plastic collar, the cross-section may be up to 1.5 mm².
For single-wire cores, AWG28 – AWG12 can also be used.
- The cable ducts installed by the manufacturer in the device have a clamping range of 4.5 to 10 mm. This means that the external diameter of the laid cable must remain within the range of 4.5 to 10 mm. If you use other ducts, the cable diameters must correspond to the ducts.

NOTE

Optimum cross-section of the cores

If the core cross-section is less than 0.5 mm², jamming may occur when the cores are loosened from the terminal strip. We therefore recommend using wires with cross-sections greater than 0.5 mm².

Requirements for cable ducts

- The recesses in the housing are intended for M16 ducts.
- The ducts should have a smooth and rounded opening (to protect against bending and abrasion).
- The duct should include a strain relief that prevents slippage of the cable and that cannot be disengaged without a tool.
- You can order cable ducts from us as spare parts (see [Testomat® Modul TH-R spare parts and accessories](#) on page 48).

**WARNING****During assembly**

- Always disconnect the relevant system component from the power source before assembling the device or connecting it to the power supply or disconnecting it from the same. Prevent any inadvertent reactivation of the device.
- Only connect the device to the operating voltage as specified on the type plate.
- Observe the technical data and the environmental parameters.
- The connections for operating voltage and relay outputs must be laid separately from each other, to guarantee corresponding insulation between the cables.

NOTE**Avoiding interference voltages**

The Testomat® Modul TH-R device requires stable and uninterrupted supply voltage. Where applicable, use a mains filter to shield the Testomat® Modul TH-R device from interference voltages, which may be generated for example within the network by magnetic valves or large-scale engines. Never lay the connecting cables in parallel to mains cables.

**ATTENTION****Handling may cause damage or destruction of electrical components!**

If you need to open the upper door, you should take the necessary safety measures to avoid electrostatic discharge onto the components (ESD safety).

Make sure you are earthed before opening the casing.

During operation

- **The device has no On/Off switch.**
Use an external switch to turn the unit on and off. The switch must be installed next to the device and must be marked as power switch for the device - for example with a label.
- Ensure that the maximum electrical load capacity of the switching outputs is not exceeded, particularly for inductive loads. The power supply for the user inclusive device is secured with a 1 A fuse, which means the total of all loads must not reach 1 A.
- In the event of any malfunctions, immediately switch off the Testomat® Modul TH-R device and inform the service personnel. Never attempt to repair the Testomat® Modul TH-R device yourself. Doing so will invalidate the guarantee. Repairs must be performed by authorized service personnel only.

During cleaning

- Only use a dry and lint-free cloth to clean the device.
- Maintenance and care instructions are included in the section [Maintenance](#) on page 43.

Repairing a defective device

- A defective device, regardless of the guarantee period, can be serviced only when the device is dismantled and the error is described. Also inform us of the indicator type currently in use, the batch number and the measured medium. Make no changes or modifications to the device that go beyond the scope of use specified in these instructions. Doing so will void the warranty. This applies particularly to the measuring chamber, the seal of which must remain undamaged. If you send the device in for repair, completely empty the measuring chamber and remove the indicator bottle and the drain funnel.

Before dismantling, the type of error must be noted (error number, error effect, log file of the SD card).

- Once a protective device has been triggered (safety fuse), initially try resolving the cause of error (e.g. by replacing a defective valve), before reactivating the protective device. Frequent triggering always signifies an error, which under certain circumstances may also damage the device.

During disposal

- Dispose of the device in accordance with the regulations of your country.

Batteries:



The device is built with a removable lithium battery (CR2032 / 3V) made by VARTA or similar.

Batteries and devices must be disposed of separately! Dispose of batteries in accordance with the guidelines in your country.

**CAUTION****Operating requirements**

- Problem-free operation of the Testomat® device is only possible when using Heyl Testomat 2000® indicators and only within the pH range of 4 – 10.5! Using external indicators may invalidate the guarantee.
- Only operate the device within the scope of parameters specified under section [Technical data](#) on page 52.
- When operating without the instrument cover (Art. No. 37798), only protection class IP 40 is valid.
- For Testomat® devices used to monitor water hardness, large quantities of heavy metal ions in the hardened water may disturb the color reaction, particularly
 - Iron over 0.5 mg/l
 - Copper over 0.1 mg/l
 - Aluminum over 0.1 mg/l (brown-red color indication).
- If the test water contains more than 20 mg/l CO₂ (carbonic acid), erroneous evaluations cannot be ruled out. In this case, use an irrigator (e.g. optional accessory from Gebr. Heyl.).
- The water to be measured must be clean and free of bubbles!
- The concentrations of disruptive ingredients can be determined with colorimetric TESTOVAL® test comparators from Gebr. Heyl.
- Erroneous evaluations can occur in the event of
 - excessive carbonate hardness
 - the presence of disinfecting agents
 - the presence of silicate (used to protect pipes). The measuring chamber may become soiled.
- Careful handling of the device enhances the operational safety and the service life! With this in mind, perform a visual inspection of the device at regular intervals as follows:
 - Has the expiry date of the indicator elapsed?
 - Are the hose connections of the dosing pump leakproof?
 - Is there any air in the dosing hoses?
 - Are all water connections leakproof?
 - Is the device excessively soiled?
 - Are the measuring chamber and drain channel/drain hose clean?
- Problem-free operation is contingent on regular maintenance! Maintenance and care instructions can be found in the [Maintenance](#) section on page 43.
- Indications of problems can be found in the [Error messages and troubleshooting](#) section on page 34.

NOTE

Scope of delivery

1x Testomat® Modul TH-R

1x plastic bag including a screw cap with hole and an insert for the indicator bottle

1 package with 1 plastic bag with drain funnel

1 User manual

Performance specifications

- The scope of use of the Testomat® Modul TH-R is the automatic determination of the residual total hardness (water hardness) in water. In the process, the required measurement scope is determined based on the selected indicator and corresponding user programming.
- The device is connected to an overriding control system.
- The output of the measurement values occurs via a 4-20 mA interface and via RS232 interface.
- Analysis trigger:
 - Interval mode (the interval pause can be adjusted from 0-99 minutes)
 - External analysis input (start/stop)
 - Manual starting.
- Shared output for the alarm



Connect to the max. 35 VAC / 60 VDC relay.

- Parameterisation with the Service Monitor program, logging of error and maintenance messages and a firmware update with the SD card
- USB connection for service purposes and for parameterisation with the Service Monitor program
- History for error and maintenance messages
- Free selection of hardness units in °dH, °f, ppm CaCO₃, or mmol/l
- Highly accurate measurement thanks to the use of precise piston-dosing pump
- Built-in self-test with ongoing monitoring
- Extended operating periods due to a 500 ml reagent stock

Interaction with the controller

When using the 4-20 mA interface, the Testomat® Modul TH-R sends its determined measurement result as a current value to the controller, which determines the measurement value from the current, e.g., in °dH.

The reagents used determine the device's measurement range.

To calculate the measurement value, the controller requires the measurement range final value for the indicator model used. This is assigned to the 20.0 mA current.

When using the RS232 interface, the Testomat® Modul TH-R transfers its determined measurement result to the control system. All measurement data and error messages are always transferred to the RS232 interface, even if they are not used.

Available indicators

		Parameter/indicator type				
		Water hardness				
		TH 2005	TH 2025	TH 2050	TH 2100	TH 2250
Unit	°dH (resolution)	0.05 - 0.50 (0.01)	0.25 - 2.50 (0.05)	0,5 – 5,0 (0,1)	1.0 - 10.0 (0.2)	2.5 - 25.0 (0.5)
	°f (resolution)	0.09 - 0.89 (0.02)	0.45 - 4.48 (0.1)	0,89 – 8,9 (0,2)	1.8 - 17.9 (0.4)	4.5 - 44.8 (1.0)
	[ppm] CaCO₃ (resolution)	0.89 - 8.93 (0.2)	4.5 - 44.8 (0.9)	8,9 – 89 (2)	18 - 179 (3.8)	45 - 448 (10)
	mmol/l (resolution)	0.01 - 0.09 (0.01)	0.04 - 0.45 (0.01)	0,09 – 0,89 (0,02)	0.18 - 1.79 (0.04)	0.45 - 4.48 (0.1)

NOTE

Be careful to ensure that Heyl indicators are used!

Using external indicators may result in considerable measurement deviations or measurement errors. Damage caused by foreign particles in the area of the dosing pump, measuring chamber or valves is also possible. This may invalidate the guarantee!

At Heyl, we always strive to ensure the consistently high quality of our indicators. They are specially tailored to the requirements of our measuring devices and guarantee flawless measurement results.



CAUTION



NOTE

Assembly

Hazard due to defective assembly!

- Assemble the Testomat® Modul TH-R device in a location shielded from drips and splashes of water, dust and aggressive substances – e.g. in a switching cabinet or on a suitable wall.

Notes for problem-free operating procedures

- Assemble the Testomat® Modul TH-R device vertically and without mechanical stresses.
- Assemble the Testomat® Modul TH-R device in a location free of vibration.

Assembling the Testomat® Modul TH-R

Requirements for the installation site

We recommend short intake lines (under 3 m) to the Testomat® Modul TH-R. For intake lines longer than 3 m, purge periods of longer than 60 s must be configured (see section [Internal "Flush time"](#) on page 29).

Measurement error under strong incidence of light

When installing and operating without the instrument cover (Art. No. 37798), avoid direct sunlight or strong incidence of light, as this may impair the measurement.

- Drill the mounting holes as specified in the accompanying sketches.
- Secure the device with three screws in a suitable place in the switching cabinet or on the wall.



NOTE

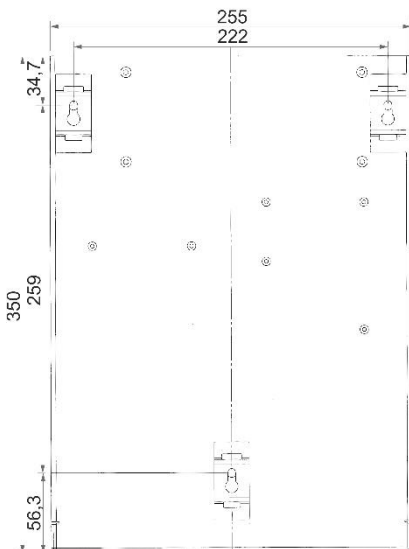

Use of the Testomat® Modul TH-R within a pressure range of 0.3 to 1 bar

Before assembling, please check whether adaptation to a lower working pressure is required. When delivered, the device is equipped for a pressure range of 1 to 8 bar. To operate the device within a pressure range of 0.3 to 1 bar, the flow controller valve body ② should be removed (e.g. when using a type R mini irrigator, see section [Additional accessories](#) on page 51). For this purpose, take the locking pin ③ from the controller/filter housing ④. Then pull the controller plug ① on the metal brackets out of the drill hole. Then remove the flow controller valve body ② and re-insert the controller plug and locking pin.

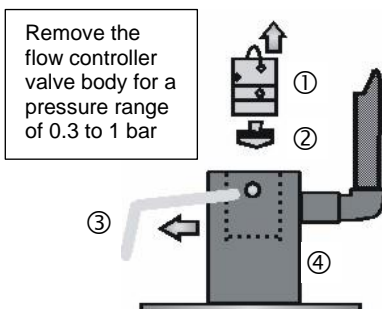

At pressures under 0.3 bar or when sucking out of a tank, our MepuClip booster pump can be used (see section [Additional accessories](#) on page 51).

Connecting the water intake and discharge



CAUTION

When using a cooler

- Water exceeding 40 °C may lead to burns and may damage the parts of the Testomat® Modul TH-R exposed to the water.

NOTE

Notes for problem-free operating procedures

- The water pressure must be within the range 0.3 to 8 bar.
- To operate within a pressure range of 0.3 to 1 bar or when supplying via a booster pump, please remove the controller valve body from the controller and filter housing. The pump should have a capacity of 25 to 35 liters/hour and be correspondingly resistant to the medium being measured (e.g. our booster pump MepuClip Art. No. 270410).
- For operation exceeding 8 bar, a pressure reducer must be used.
- Significant pressure fluctuations should be avoided.
- The measurement water temperature must be between 10 and 40 °C.
- For water temperatures exceeding 40 °C, a cooler must be installed in the intake of the Testomat® Modul TH-R.

Water intake

The test water is extracted from the sampling pipe and channelled to the supply nozzles of the Testomat® Modul TH-R. The device comes with a plug connection for plastic hoses 6/4 x 1 as standard (external diameter 6 mm / internal diameter 4 mm, wall thickness 1 mm).

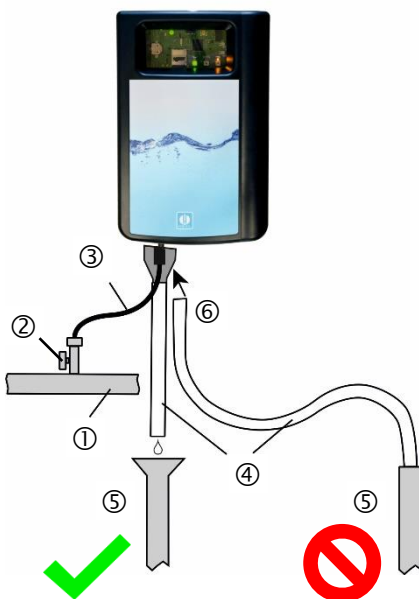

- Connect the linking piece for the water intake ③ of the Testomat® Modul TH-R directly to the sampling pipe ① directly behind the water treatment plant.
- Always establish the connection vertically upwards, to prevent dirt particles from being conveyed from the sampling pipe to the device.
- Assemble a manual stop valve ② in the water intake ③ to the Testomat® Modul TH-R.
- For the water intake use opaque plastic pressure hose 6/4 x 1 (max. length 5 m).
- Purge the water intake to remove dirt particles.

Water drain

The water is conveyed through the measuring chamber via an open funnel ⑥ and the drain hose ④ installed on the same and into the duct.

- Remove the supplied funnel.
- Accommodate the funnel ⑥ underneath, in the recess of the housing designated for that purpose.
- Connect the funnel of the Testomat® Modul TH-R with a drain hose ④ (internal diameter 12 mm).
- Lay this hose ④ **free of back pressure** and without the siphon effect to the drain ⑤.

Connect mains and devices

- Connect the device only to a 24 VDC power supply.



Risk of injury from assembly when voltage is present!

Unless you disconnect the power supply before commencing assembly, you risk injury, destruction of the product or damage to system components.

- Disconnect all power to the relevant system component before assembling the Testomat® Modul TH-R device.
 - When connecting, use only verified cables with sufficient line cross-section (see [Requirements of cable for operating voltage and system components and installed lines](#) on page 6).
-

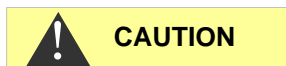

Danger of damage due to electromagnetic fields!

If you assemble the Testomat® Modul TH-R device or connecting cables parallel to mains cables or in the vicinity of strong electromagnetic fields, the device may be damaged, or the measurement disrupted.

- Keep the connecting cables as short as possible.
 - Lay the connecting cables and mains cables separately.
 - Shield the device from strong electromagnetic fields.
-

Block diagram of Testomat® Modul TH-R

Illustrated position of relays: Device without current

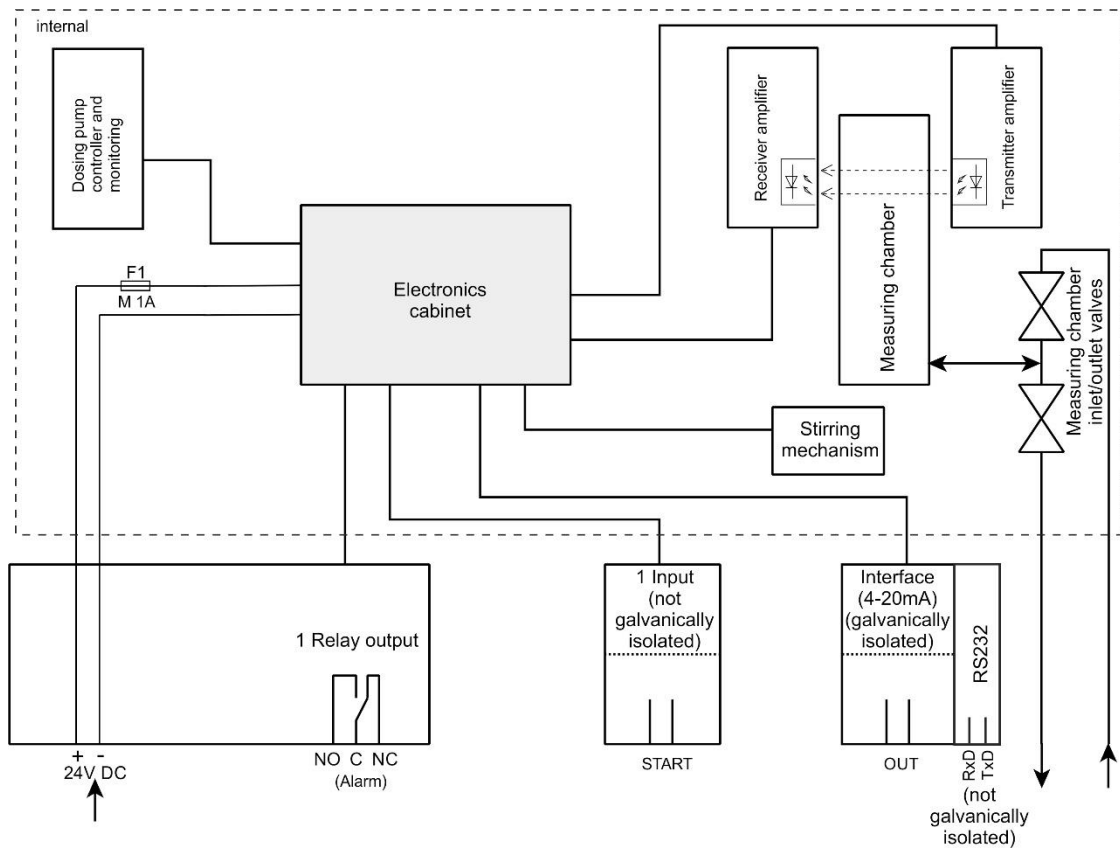

Connecting inputs and outputs



Correct connection of the inputs and outputs

Incorrect connections will damage the device!

- Do not expose the connections to any external voltage!
- Ensure that the cores in the terminals are securely in place.

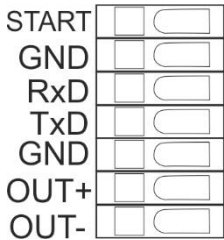

Terminal designation	Type	Function	Note
OUT + OUT -	OUT	Current loop 4 - 20 mA	Galvanically isolated
START GND	IN	External start/stop of analysis Ground	Only connect isolated break contacts/closing contacts!
GND	IN	Ground	
RxD TxD	IN OUT	RS232 interface	Not galvanically isolated (RxD currently not in use)

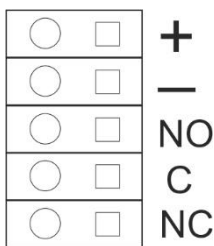

Terminal designation	Type	Function
+ / -		Operating voltage
NO		Alarm output – NO contact
C		Alarm output – Root
NC		Alarm output – NC contact

A detailed description is included in section [Description of the signal inputs and outputs](#) on page 32.

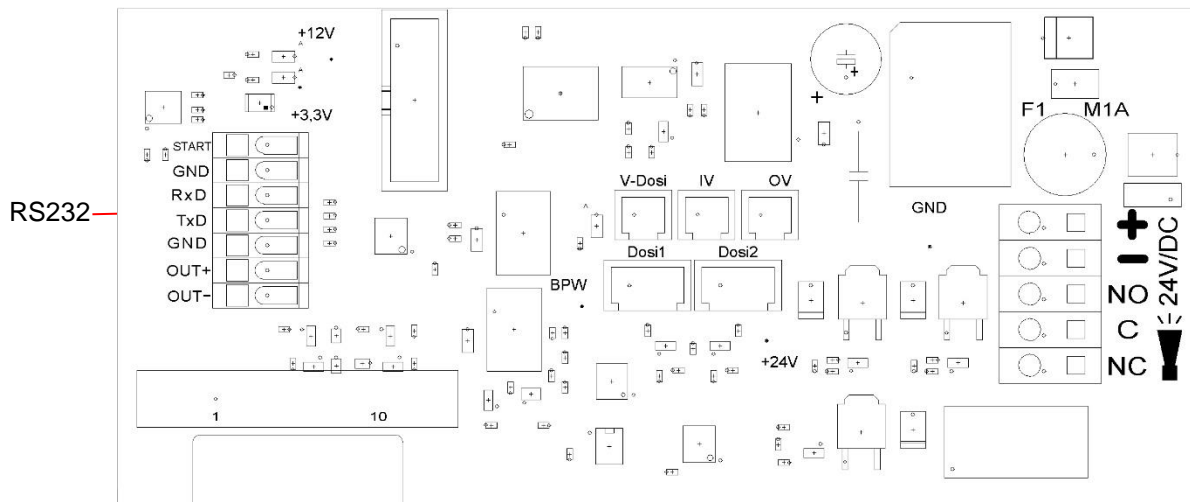

Internal design Testomat® Modul TH-R

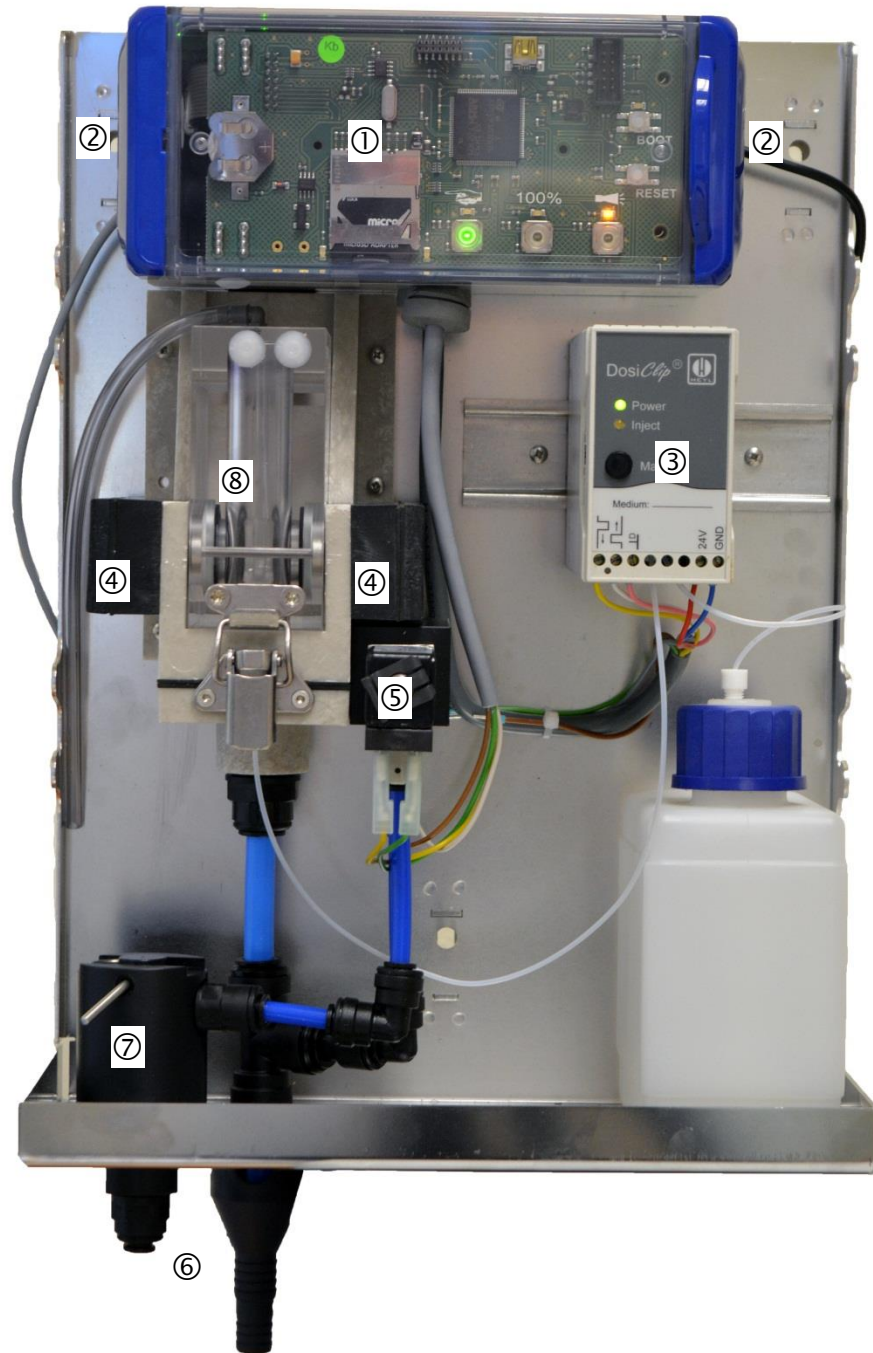

①	Control circuit board, Base circuit board with terminal strips for inputs and outputs is behind
②	Cable gland on both sides
③	Dosing pump
④	Optical unit (transmitter right/receiver left)
⑤	Solenoid valve
⑥	Water connections, inlet and outlet
⑦	Controller / Filter receiver
⑧	Measuring chamber

Commissioning



Flawless operation of the Testomat® Modul TH-R device is only guaranteed when Heyl indicators are used! The use of external indicators may invalidate the guarantee.

Inserting the indicator bottle

- Remove the cover of the Testomat® Modul TH-R. To do this, raise the cover slightly and push it forward to remove it.
- Remove the cap from the indicator bottle.
- Remove the plastic bag from inside the lower housing door. The plastic bag contains the screw cap with hole ① and the insert ② for the screw cap.

Connect the parts as shown on the left:

- Screw the hose connector ③ of the intake hose ④ hand-tight into the insert ②.
- Place the insert with the screwed-in intake hose into the indicator bottle ⑤.
- Now screw the screw cap with hole ① hand-tight onto the indicator bottle.

Opening the water inlet

- Slowly open the manually operated shut-off valve to prevent the measuring chamber ⑩ from overflowing. The flow controller requires a few seconds to function correctly.
- Make sure that the water conducting parts are not leaky.
- If water sprays from the tube ⑨ of the measuring chamber ⑩, reduce the amount of inlet water via manually operated shut-off valve. It should take 2 to 6 seconds to fill the measuring chamber!

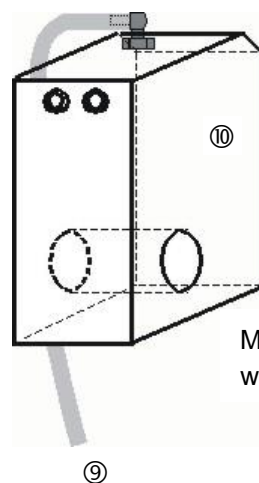
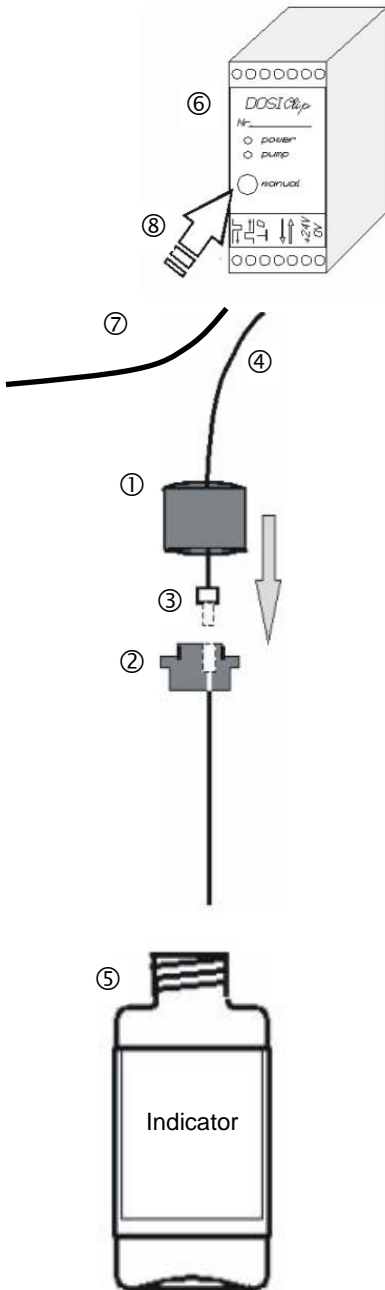

Measuring chamber ⑩
with tube ⑨

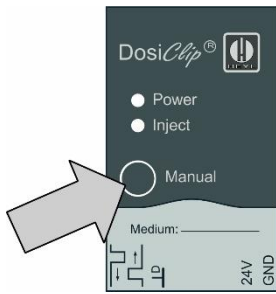

Venting indicator line

The pump (DOSIClip) ⑥ automatically primes the indicator in operation.

The pump's suction hose ④ and transport hose ⑦ must be filled with the indicator up to the measuring chamber so indicator is present for initial analyses.

- To do this, press the "Manual" button on the DOSIClip pump several times until the suction and transport hose are filled with indicator up to the measuring chamber.
- In the event of a build up of bubbles, turn the suction and transport hose's hose connector a bit tighter by hand if required.
- Press the **Manual** function key on the control circuit board to quit standby mode.

The device starts the analysis.

Functions of the operating and display elements

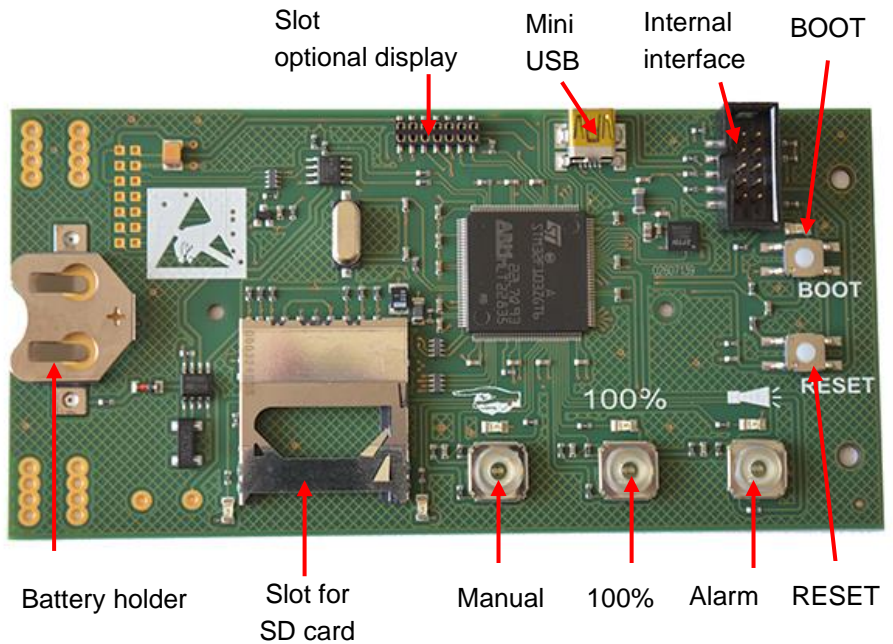

Function keys



The **Manual** function key is used to start the standby mode which prevents the intermittent start of an analysis. The yellow LED flashes above the key in the process. After pressing the key again, the standby mode is cancelled again, and an analysis starts. During an analysis, the key flashes.



Acknowledge error and maintenance messages with the **Alarm** function key. An alarm message (key lights up red) is acknowledged when the error has been corrected. The key's light goes out. A maintenance message (the LED above the key lights up yellow) is acknowledged when the maintenance work has been performed.



You can set the indicator stock to 100% with the **100%** function key (see section [Changing an empty indicator bottle](#) on page 45).

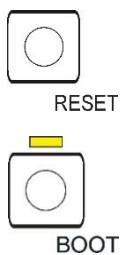

- **RESET key:** To reset the controller, proceed as for switching on and off.

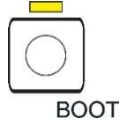

- **BOOT key:** Used for firmware update and selection mode.

- **Plug-in slot for SD card:** For parameterisation, errors and maintenance messages and firmware updates



- **USB socket:** For connecting a computer to the Service Monitor for parameterisation.

- **Battery holder:** The battery holder houses a CR2032 lithium battery to retain the time setting even if the device is switched off.

Display elements of the function keys

The Testomat® Modul TH-R has three display elements: **Manual**, **Alarm** and **100%**.

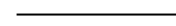

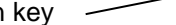





Each element consists of:

1. Symbol 
2. LED 
3. Function key 

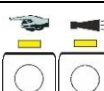
The LEDs and function keys can adopt 3 states:

- OFF
- Light up
- Flash

You can find the display elements' different statuses and their meanings in the following table:

Display elements and their states	Meaning
 Manual lights up green:	The device is now ready for operation.
 Manual flashes green:	An analysis is currently being performed.
 LEDs above Manual and Alarm light up yellow:	The USB interface is active for communication with the computer.
 LED above Manual flashes yellow:	The device is in standby mode, i.e. it does not perform further analyses.
 Alarm lights up red:	An error has occurred.
 Alarm flashes red:	A temporary malfunction has occurred (water shortage, turbidity, dirt contamination).
 LED above Alarm lights up yellow:	Maintenance must be performed.
 100% lights up red:	The reagent stock is depleted.
 100% flashes red:	The reagent stock is only sufficient for less than 50 analyses.

NOTE

The function keys are also used to operate the Testomat® Modul TH-R. You will find individual explanations and processes in the following chapters.

Adjusting parameters in the device

Adjust parameters such as time and date and interval pause in the Service Monitor and then transfer the data to the device. To do this, you must connect the Testomat® Modul TH-R to a computer that has the Service Monitor software stored on it (see section [The Service Monitor program](#) on page 27).

You must start the device's selection mode to establish a connection between the Testomat® Modul TH-R and the computer.

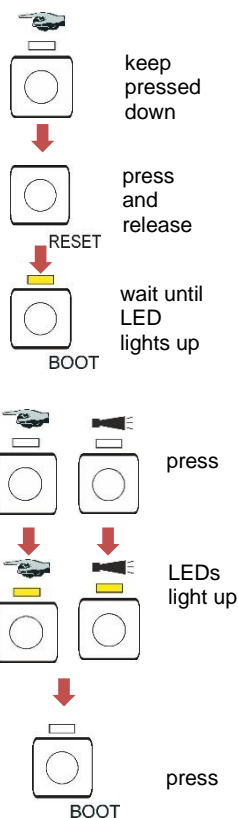

Calling up selection mode on the device

- Open the electronics housing lid.
- Press and hold one of the three function keys **Manual**, **Alarm** or **100%** down throughout the whole process.
- Press the **RESET** key once.
- Keep the function key pressed down until the yellow LED above the **BOOT** key lights up.

The device is now in selection mode.

Starting USB communication

- Connect the computer and the Testomat® Modul TH-R with a USB cable.
- Start the Service Monitor program on the computer.
- Press the **Manual** function key.
- Press the **Alarm** function key.
- Confirm by pressing the **BOOT** key.
The LED over the **BOOT** key goes out.

The LEDs above the two function keys light up to show that communication is active.

Entering parameters via the Service Monitor program

Enter the desired parameter in the Service Monitor (description of all possible parameters under section [Adjusting parameters](#) on page 28).

The entered parameters are written straight onto the device with the "Export Data" button, if "Device" is selected.

- Close the program with the "Close" button.
- Disconnect the USB connection between the device and computer.

Exiting selection mode

- Press the **RESET** key to exit selection mode.



NOTE

How to proceed after reset

The software is loaded again after the reset, and the device carries out ventilation prior to analysis.

Start of measurements

Once you have completed the steps in the [Commissioning](#) section, you can supply the device with power.

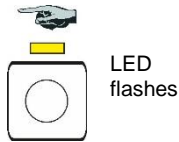

- Switch on the device.

Start the first measurement:

- Press the **Manual** function key once. The LED above the **Manual** key flashes yellow.

After the first measurement the device reverts to standby mode.

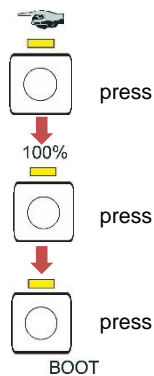

Other functions in selection mode

Importing basic programming data from the SD card into the device

- Press the **Manual** function key.
- Press the **100%** function key.
- Press the **BOOT** key.

The yellow LED next to the SD card lights up briefly.

The device then returns to normal interval operation.

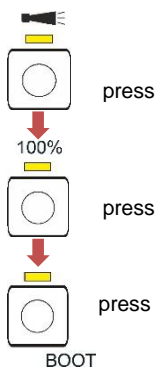

Exporting basic programming data from the device onto the SD card

- Press the **Alarm** function key.
- Press the **100%** function key.
- Press the **BOOT** key.

The red LED next to the SD card lights up briefly.

The device then returns to normal interval operation.

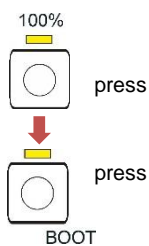

Resetting to factory settings

- Press the **100%** key.
- Press the **BOOT** key.

The device then returns to normal interval operation.

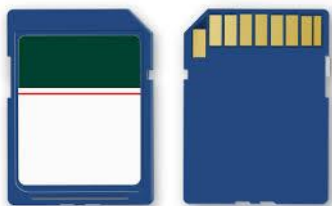

Functions of the SD card

The SD card is used to import and export device settings, to log the error and maintenance messages and to update the firmware.

Caution! Measurement data and error messages are only saved when the SD card is in the device.

To read and change the data on the SD card, you need the [Service Monitor](#) program.

Storage of measured values and alarms

Error and measurement files are stored in subfolders separated by year and month:

- One file each for measured values and errors per month is stored in the folder of the year. The file name format is:
 ME<year><month>.csv for measured values and
 AL<year><month>.csv for errors/alarms.
- If required, subfolders for the 12 months of the year are created in the folder of the year and one file each for measured values and errors per day is created there. The file name format is:
 ME<year><month><day>.csv for measured values and
 AL<year><month><day>.csv for errors/alarms.
- Data is stored in “Comma-Separated-Value” format to allow it to be easily imported into spreadsheet programs and databases.
 - Column 1 indicates measured value “ME” or alarm “AL”.
 - Column 2 shows the indicator used to determine the measuring range.
 - The M1 column contains the designation of the measured quantity (TH for Total Hardness).
 - The actual measured value and its unit follow after M2.
 - The devices have no adjustable limit values and only one measuring channel. The columns “M2”, “limit” and “limit value” are included only for reasons of compatibility with other devices.

The storage of measured values and alarms/messages on the SD card is always active as long as it is plugged in.

The file format is ASCII, DOS. The file for measurement data, for example, is created as follows:

```
sep=,
"type","parameter","date","time","M1","M2","meas.value","unit","limit"
,"limit value","limit","limit value",
ME,TH2005,24.06.2020,11:54,TH,-,0.10,°dH,limit val.1,0,limit val.2,0
ME,TH2005,24.06.2020,11:56,TH,-,0.20,°dH,limit val.1,0,limit val.2,0
ME,TH2005,24.06.2020,12:51,TH,-,0.30,°dH,limit val.1,0,limit val.2,0
ME,TH2005,24.06.2020,13:33,TH,-,0.35,°dH,limit val.1,0,limit val.2,0
ME,TH2005,24.06.2020,13:55,TH,-,0.37,°dH,limit val.1,0,limit val.2,0
```

In the file, the comma is explicitly set as separator in the first line "sep=," to allow the file to be imported directly into Microsoft Excel. If OpenOffice/LibreOffice Calc is used, this row appears after the im-

port. It can be deleted. After that comes the prefix, so that the column titles are named in Office programs. This is followed by the actual data.

The file format for messages is similar:

```
sep=,
"error message","date","time",
AL,25 Change pump head 1,24.06.2020,10:26
AL,24 Indicator low,24.06.2020,10:26
```

NOTE

Connection between time and correct data

For the names of the files and the date and time information in the file to be correct, the clock must be set and working. If the battery is depleted or no time is set, the date 1.1.2011, 12:00 is assumed automatically and the data is saved. Data is not lost, as new measured values and errors are appended to the existing files. However, only one file is then written to at a time, since month and day changes do not occur.

Functions of the USB connection

Installing the USB driver

Install the appropriate USB driver on the computer so you can use the USB interface. You can find the VCP driver suitable for the operating system on the www.ftdichip.com internet page.

NOTE

USB connection to several devices

If the same computer is connected to other devices, the driver defines a new COM port for each device!

Establishing a connection between the Testomat® Modul TH-R and the computer

- Connect the computer and the Testomat® Modul TH-R with a USB cable.
- Start the [Service Monitor](#) program on the computer.
- Start selection mode on the Testomat® Modul TH-R with both function keys **Manual** and **Alarm** (see [Calling up selection mode on the device](#) on page 22).
- Start the USB communication (see [Starting USB communication](#) on page 22).

The yellow LEDs above the **Manual** and **Alarm** function keys light up when connecting.

Now data can be displayed and processed by the device in the Service Monitor program.

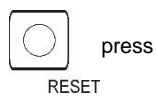

Disconnecting the connection between the Testomat® Modul TH-R and the computer

- Remove the USB cable to disconnect the connection.
- Press the RESET key to return the device to its normal operating mode.

The device carries out ventilation after the reset.

The Service Monitor program

The Testomat® Modul TH-R settings can be displayed and changed with the Service Monitor program (for operating systems from Windows 7 onwards). The program is stored on the SD card of the device.

To work with the Service Monitor, the SD card from the device must be inserted into the computer (see also [Functions of the SD card](#) on page 24) or the device must be connected to the computer that the program is running on, via the USB interface (see also [Starting USB communication](#) on page 22).

Installing the Service Monitor

The Service Monitor program consists of:

- the “TestomatModul.exe” file and
 - the “TestomatModul_TH_R.cfg” configuration file.
- Copy both files to the target computer.
 - Start the “TestomatModul.exe” file.
 - When USB communication is established, select “Port” under the “USB” field and press the “Open” button.
 - Select the appropriate device under “Device selection”.
 - Load the firmware version into the device under “Read version”.
 - Configure your settings.

Selecting language

“German”, “English”, “French”, “Dutch” or “Portuguese” can be selected as a menu language under the “Language” tab.

Adjusting parameters

“Device selection” field

Select the connected device, e.g. Testomat® Modul TH-R.

NOTE

Select device before loading the version

If you change the device selection after loading the version, the serial interface is closed and the USB communication is terminated.

“USB” field

Select the port number used by the computer. It is assigned during the USB driver’s installation.

“Date time” field

The system time is adopted from the connected computer with the “Set time” button.

Automatic switching between summer and winter time can be activated with the “Summer/wintertime automatically” check mark.

Date and time in messages

The date and time must be set to provide a time stamp in the history of the error messages, maintenance messages and measured values. If the time is not set, the timestamp records *01.01.2011; 12:00*.

NOTE

“Version” field

The version number and the creation date of the software used (boot-loader and firmware) are read from the device and displayed using the “Read version” button.

“Settings” field

Set the interval pause, flush time, indicator type and unit.

a) when programming a device via the USB interface:

After the variables have been imported from the device using the “Import data” button, they are displayed, These variables can be edited in the input field (light).

The changed variables are then transferred to the device with the “Export data” button. The new values then appear in the output field.

b) when programming a SD card:

After the variables have been read from the SD card using the “Import data” button, they are displayed in the output field (grey). This variable can be edited in the input field (light).

The changed variables are then transferred to the SD card with the “Export data” button.

“Input Stop”

“Input Stop” is set as normally open by factory. If you want to use the input as normally open, place the check mark next to "normally open". If you want to use the input as normally closed, delete the check mark.

Internal “Flush time”

To guarantee that the water sample being analysed is current, the sampling pipe must be sufficiently flushed beforehand over its entire length.

Flushing is carried out by simultaneously opening the inlet and outlet valves of the device.

- You can enter values in the range of 0 to 180 seconds. The factory default setting is 0 seconds.
0 seconds means that no internal flushing should take place.

“Interval pause”

A waiting time between two analyses can be set to determine a specific analysis interval.

- You can enter values in the range of 0 to 255 minutes. The factory default setting is 15 minutes.
0 minutes means that there is no pause between two analyses.
Non-stop analyses are carried out.

NOTE

Duration of the analysis interval

The analysis interval is comprised of:

- the analysis duration (depending on the indicator used and on the residual total hardness (water hardness) to be measured, which takes approx. 5 minutes. The higher the water hardness, the more time it takes to analyse.),
- the interval pause that has been set and
- the flushing time that has been set.

„Interval pause after water low”

If the instrument detects a lack of water during an analysis, the measurement is repeated twice before an alarm is issued.

Set the time until the next repetition here.

- You can enter values in the range from 0 to 180 minutes. The factory default setting is 0 minutes.
0 minutes means that there is no pause between repetitions.

“Total operating time” display

The display shows the device’s total operating time in hours.

“Service interval” field

Set the maintenance interval in days here, if you want to be reminded about regularly maintaining the device (see also [Maintenance message](#) on page 42). Load the maintenance interval into the device using the “Reset service” button.

- You can define a maintenance interval that reminds you about regularly maintaining the device. You can enter values in the range of 0 to 365 days.

The factory default setting is 0 days.

0 means that no maintenance message should occur.

You can see when the next service is due under “Next service in”.

The message “Maintenance” is logged.

“Import” field

All settings are loaded into the service monitor with the “Import Data” button. Select whether the data from an SD card inserted in the computer or from the connected device should be adopted via USB communication.

The basic programming data on the SD card is in the “TestomatModul_TH_R.cfg” configuration file.

“Export” field

When you have changed the settings, you can save it onto the SD card or into the connected device with the “Export Data” button. Select whether you want to load the data onto an SD card, or straight into the device via USB communication.

The basic program data is written into the “TestomatModul_TH_R.cfg” configuration file when using an SD card.

“Error messages” tab

The error history is loaded from the device and displayed in the “Error history” field when you press the “Read” button. You can see when error and maintenance messages have occurred.

The error list is cleared from the window with the “Clear window” button.

The SD card errors and maintenance messages are not displayed.

Example: Changing the interval pause in the Service Monitor for Testomat® Modul TH-R

1st option: Directly on the device via the USB interface

- Switch the device to selection mode (see [Calling up selection mode on the device](#) on page 22).
- Connect the computer with the USB socket of the device.
- Start the “TestomatModul.exe” program on the computer.
- Start the “USB communication” function with the **Manual** and **Alarm** keys and the BOOT key (see [Starting USB communication](#) on page 22).
- Select the USB port in the service monitor and press the “Open” button.
- Select the appropriate device under “Device selection”.
- Load the firmware version into the service monitor using the “Read version” button.
- Select “Device” as a data target under the “Import” field and press the “Import Data” button.
The data from the device is displayed under “Settings”.
- Enter the desired interval pause in the light field under the “Interval pause” field.
- Select “Device” as a data target under the “Export” field and re-store the data with the “Export Data” button.
- Close the service monitor with the “Close” button.
- Disconnect the USB connection.
- Exit the selection mode with the RESET key.

2nd option: Using the SD card on the computer

- Remove the SD card from the device and insert it into the computer.
- Start the “TestomatModul.exe” program.
- Select “SD card” as a data target under the “Import” field and press the “Import Data” button.
The data from the device is displayed under “Settings”.
- Enter the desired interval pause in the light field under the “Interval pause” field.
- Select “SD card” as a data target under the “Export” field and re-store the data with the “Export Data” button.
- Remove the SD card from the computer and insert it into the device again.
- Switch the device to selection mode (see [Calling up selection mode on the device](#) on page 22).
- Import the data in selection mode from the SD card to the device (see [Importing basic programming data from the SD card into the device](#) on page 23)
- Exit selection mode with the RESET key.

Description of the signal inputs and outputs



Switching of the signal input

Switching with external voltage will damage the device!

- Switch the control input “STOP/START” only with *isolated* contacts!

Control input STOP/START

The input is intended for short-term suspension of operation, e.g. when performing renewal work on softening plants, reverse osmosis or other water treatment systems. Generally speaking, the system is not offline for more than six hours. The renewal phase of a softening plant, for example, lasts three hours at most.

Function	Contact type	Testing duration	Action
STOP/START External analysis stop (e.g. via flow monitor or process control)	Normally open (isolated)	None	While the contact is closed at the input, no analyses are performed

If the control input is active, an analysis is prevented from starting, for example due to an interval having elapsed. This may be required, if the system lacks water. However, any analysis already started will not be suspended. The analysis is completed, and the device reverts to standby mode.



Where the signal is present, the LED above the **Manual** function key flashes. If the signal is deleted, a new analysis starts immediately.

Accordingly, a short impulse on the control input can help trigger an analysis remotely.

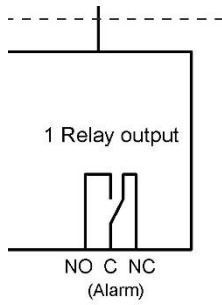

Fault signal output “Alarm”

The “Alarm” output is an isolated relay changeover contact. During fault-free operation, the contact between the terminals NO - C is closed and opened between NC - C. In the event of a fault or voltage failure, the contact between the terminals NO - C is opened and closed between NC - C.

Current output 4-20 mA

The current output supplies the measurement value to the current input of the connected master controller.

NOTE

Loading the current loop

The maximum load of 500 Ohm must not be exceeded!

In the event of faults and very long lines (around 20 m), the use of a shielded cable is recommended.

Calculation of output currents

How is the current calculated for a specified measurement value?

Function
4-20 mA

$$\text{current} = \frac{\text{measurement value}}{\text{measurement range upper limit}} \times 16 \text{ mA} + 4 \text{ mA}$$

The measurement range upper limit is dependent on the indicator used.

NOTE

Accuracy of the measured value output

Please calculate the measured values from the output current to a max. resolution of 0.1 ppm.

Serial interface

The serial RS232 interface transfers measurement data and alarms or notifications in plain text or ASCII in CSV format. It is always active. The baud rate is set to 9600.

Transmission is in the 8 bit format, 2 stop bits, no parity.

A new measurement value is transmitted as soon as it has been determined. New alarms are transmitted via the serial interface and some alarms even when the alarm has been ended (see [Error messages and troubleshooting](#) on page 34).

Notification format

The messages are stored in “Comma Separated Value” format:

- Field separator is a comma.
- Decimal separator is a full stop.
- Each data set is started with the ASCII characters “02” <STX> and terminated with “03” <ETX>.
- Notifications and measured values can be distinguished by evaluating the first characters: If “ME” is read, it is a measured value; with “AL”, it is an alarm or notification.
- This corresponds to the format of the Testomat 2000® data logger.
Even though the device does not have a limit value function, the same fields are transferred for compatibility reasons.

Example of measured value:

```
<STX>ME,TH2005,31.07.2013,08:09,0.050,°dH,limit  
val.1:,0.200,°dH,limit val.2:,0.300,°dH<ETX>
```

Examples of notifications:

```
<STX>AL,turbidity,01.08.2013,07:30<ETX>  
<STX>AL,turbidity inactive,01.08.2013,07:35<ETX>
```

Remote control via RS232 interface

Testomat® Modul TH-R can process four commands (IMPORT, EXPORT, CS_ERR and SW_RST), which are described below.

Caution!

Only the IMPORT command can put the Testomat® Modul TH-R into configuration mode. This is only possible during the measurement pauses. If the IMPORT command is sent to the unit during a measurement, it will be ignored. Therefore, the remote terminal must be provided with a TIMEOUT for the IMPORT command.

The IMPORT command

The IMPORT command is used to put the unit into configuration mode and read out the unit's parameters. The sequence to be sent by the control unit must be structured as follows:

```
"<STX> | IMPORT | <CSL><CSH><ETX>"
```

Since this command does not contain any variables, the checksum is constant. Therefore, the string to be transmitted looks like this:

```
"<STX> | IMPORT | 4BD8<ETX>"
```

The Testomat receives this string, forms the checksum to be able to verify the transmission and then sends the following response:

```
"<STX> | IMPORT | BL_VER=<VAL> | FW_VER=<VAL> | THOURS=
<VAL> | SRVINT=<VAL> | SRVCNT=<VAL> | SUMWIN=<VAL> | FLSH_T
=<VAL> | INTV_T=<VAL> | INDICA=<VAL> | UNIT_T=<VAL> |
STASTP=<VAL> | IP_AWL=<VAL> | <CSL><CSH><ETX>"
```

List of values (<VAL>) that the individual variables can assume (and their possible value ranges):

Bootloader Version	"BL_VER=00 22.02.18"
Firmware Version	"FW_VER=183-002 27.07.20"
Total Operational Hours	"THOURS=0" to "THOURS=4294967295"
Service Interval Days	"SRVINT=0" to "SRVINT=200"
Next Service Days Counter	"SRVCNT=0" to "SRVCNT=200"
Auto Buzzer Time Adjust	"SUMWIN=0" or "SUMWIN=1"
Flush Time Internal	"FLSH_T=0" to "FLSH_T=180"
Interval Pause Time	"INTV_T=0" to "INTV_T=255"
Indicator Type	"INDICA=0" to "INDICA=4"
Unit	"UNIT_T=0" to "UNIT_T=3"
Start/Stop Contact Type	"STASTP=0" or "STASTP=0"
Interval Pause After Water Low	"IP_AWL=0" to "IP_AWL=180"

The EXPORT command

The EXPORT command is used to write parameters to the unit.

The command must be structured as follows:

```
"<STX> | EXPORT | SRVINT=<VAL> | SUMWIN=<VAL> | FLSH_T=
<VAL> | INTV_T=<VAL> | INDICA=<VAL> | UNIT_T=<VAL> |
STASTP=<VAL> | IP_AWL=<VAL> | <CSL><CSH><ETX>"
```

List of values (<VAL>) that the individual variables may assume (and their possible value ranges):

Caution! Values outside the specified range lead to malfunctions of the Testomat® Modul TH-R.

Service Interval Days	"SRVINT=0" to "SRVINT=200"
Auto Buzzer Time Adjust	"SUMWIN=0" or "SUMWIN=1"
Flush Time Internal	"FLSH_T=0" to "FLSH_T=180"
Interval Pause Time	"INTV_T=0" to "INTV_T=255"
Indicator Type	"INDICA=0" to "INDICA=4"

Unit "UNIT_T=0" to "UNIT_T=3"
Start/Stop Contact Type "STASTP=0" or "STASTP=0"
Interval Pause After Water Low "IP_AWL=0" to "IP_AWL=180"

The command CS_ERR

The command CS_ERR (checksum error) is only sent by the unit or the remote station (e.g. PLC) if one of the other commands was not received correctly. This is the case if the received checksum does not match the calculated checksum. After sending or receiving this command, the remote terminal of the unit must send one of the commands IMPORT, EXPORT or SW_RST again, depending on the requirement.

Since this command does not contain any variables, the checksum is constant. Thus, the string to be transmitted looks like this:

```
"<STX>|CS_ERR|8C25<ETX>"
```

The command SW_RST

The SW_RST (software reset) command exits the configuration mode of the unit and performs a RESET. After the RESET, the unit starts with the new settings.

The sequence to be sent by the control unit must be structured as follows:

```
"<STX>|SW_RST|<CSL><CSH><ETX>"
```

Since this command does not contain any variables, the checksum is constant. Therefore, the string to be transmitted looks like this:

```
"<STX>|SW_RST|1D62<ETX>"
```

Formation of the checksum

To form the checksum, all characters are taken into account that lie between <STX> and <CSL>. The algorithm for checksum formation is borrowed from the MODBUS protocol. For communication between Testomat and the remote station, both units must be able to use the protocol described here, including checksum formation. On the website www.modbus.org the programmer can download the document "Modbus_over_serial_line_V1_02.pdf". The algorithm for creating the checksum is described exactly here.

Further explanations on programming

- The transmitted strings begin with STX (0x02, start of transmission) and end with ETX (0x03, end of transmission). STX and ETX are the only non-representable characters in this protocol.
- All sequences shown are in inverted commas (e.g. "5E"). These indicate transmission as an ASCII character string. Individual ASCII characters are placed in inverted commas in this section (e.g. '5').
- Since the characters STX and ETX cannot be represented, we use as notation <STX> (corresponds to the value 0x02) and <ETX> (corresponds to the value 0x03).

- The values of the transmitted parameters are also symbolised in the triangular brackets. Depending on the variable and its possible value range, the value <VAL> is composed of the following characters: '0', '1', '2', '3', '4', '5', '6', '7', '8', '9'; e.g.: "0" or "125".
- The delimiter '|' is used to separate the individual data. It corresponds to the value 124 of the ASCII table.
- To check the data transmission, a checksum is created and transmitted. This checksum consists of a low byte (CSL, checksum low) and a high byte (CSH, checksum high). The result of the checksum is transmitted in ASCII format. This means that, for example, with a hexadecimal value of 0x5E for the low byte, "5E" is transmitted in the character string. The notation in the sequences shown here is <CSL> and <CSH>, in the above example, "5E" would then be found in the string for <CSL>. The remote terminal receives the answer from the Testomat® Modul TH-R, calculates the checksum from all characters between <STX> and <CSL> and compares the calculated checksum with the checksum transmitted by the unit. If there is equality, the transmission is OK.

Error messages and troubleshooting

Temporary faults

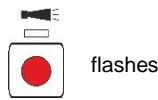

If a water shortage or if water turbidity or dirt contamination occurs, the **Alarm** key flashes. A further analysis is started after the time set under “Interval pause after water shortage” (see [„Interval pause after water low”](#) on page 29).

If the cause of the error has been corrected, analyses are performed again with the set interval pause.



If the error is still present, the **Alarm** button lights up and the device goes into standby. The alarm must be acknowledged before a new measurement is started.

Error messages

Acknowledging the alarm:

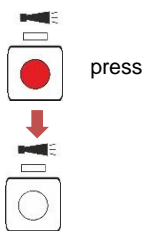

If the **Alarm** key lights up or flashes red, an error has occurred. For most errors, no further analyses are performed (see table below). The respective error is recorded on the SD card. The alarm relay switches and reports the error to the master controller. As a result, the service technician is called to the device and determines which error is present either by reading the SD card or by using a computer at the USB interface. Only after the error has been eliminated, the alarm is acknowledged, and the device can perform analyses again.

Once an alarm has been acknowledged after an interval operation has been stopped, the analysis can start.

Error number/error message	Description, possible causes	Reaction of the device	Solution, troubleshooting measures
07 SD Card Fault	SD card defective or full. No data logging is possible!	Interval operation is continued	Replace the SD card.
03 RTC bus error	The connection to the clock is interrupted.	Interval operation is continued	The device must be repaired so that the time stamp is correct.
04 RTC data invalid	The device has been switched off and the clock's buffer battery is empty.	Interval operation is started	Replace the battery; The date and time must be re-entered via the Service Monitor after the battery change.
30 Fault dosing pump 1	Dosing pump 1 is defective	Interval operation is stopped	<ul style="list-style-type: none"> Check the cable to the pump to ensure a correct connection Replace the pump and enter the new run time
33 Fault optics LED1	Error in the optical unit (light source defective)	Interval operation is stopped	Change the measurement chamber mounting
27 Fault optics LED2	Error in the optical unit (light source defective)	Interval operation is stopped	Change the measurement chamber mounting

Error number/error message	Description, possible causes	Reaction of the device	Solution, troubleshooting measures
82 Fault optics BPW	Error in the optical unit (receiver defective)	Interval operation is stopped	Change the measurement chamber mounting
80 Fault optics Imin	Automatic zero-point adjustment at stop	Interval operation is stopped	Avoid extraneous light
81 Fault optics Imax	Automatic zero-point adjustment at stop	Interval operation is stopped	<ul style="list-style-type: none"> • Clean sight glasses • Change the measurement chamber mounting
34 Fault Turbidity	The water is too turbid/soiled	Interval operation is stopped	Install an upstream water filter
35 Fault soiling	The sight-glass windows are soiled	Interval operation is stopped	Clean the sight-glass windows
37 Indicator low	Indicator stock has decreased to 10%	Interval operation is continued	see Indicator shortage on page 40
36 Fault Analysis	<p>No correct analysis, e.g.: Air in dosing hoses?</p> <p>Insufficient mixing</p> <p>Indicator expiry date exceeded</p> <p>Foreign indicator in the device</p>	Interval operation is continued to a limited extent see Temporary faults on page 38	<ul style="list-style-type: none"> • Re-tighten dosing pump connections • Renew intake insert in bottle • Check suction and pressure hose for damage • Replace stirring bar • Replace indicator, only use Heyl Testomat 2000® indicator
12 Meas. range exceeded	Measurement scope is exceeded	Interval operation is stopped	<ul style="list-style-type: none"> • Select another indicator type • Check measuring chamber and drain hoses for correct installation/blocking • Are all plugs present and sit correctly?
38 Water low	Inlet pressure is too low	Interval operation is stopped	<ul style="list-style-type: none"> • Check the water intake • Connector at the inlet valve is corroded (valve is blocked) • Clean the filter sieve and replace the valve block • Remove the pressure controller valve body • Outlet valve blocked or defective. Clean or replace the valve • Inflow rate must be at least 400 ml/min

Error number/error message	Description, possible causes	Reaction of the device	Solution, troubleshooting measures
39 Ext. light influence	External light penetrates the measurement section	Interval operation is stopped	<ul style="list-style-type: none"> • Avoid sunlight • Hardware problem. Send the device for repair
66 Fault auto remove air	Automatic venting has failed	Interval operation is stopped	<ul style="list-style-type: none"> • Possible causes can be problems with the dosing pump, optics, cloudiness, dirt contamination, analysis error or water shortage.

Indicator shortage

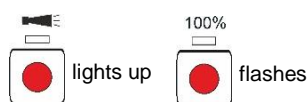

If the indicator stock is only sufficient for less than 50 analyses, the **100%** key flashes, the **Alarm** key lights up and the alarm relay switches. The interval operation is continued.

- The error can be acknowledged by pressing the **Alarm** key. The **100%** key continues to flash.
- Only after the bottle has been replaced, the **100%** key should be pressed for more than one second.

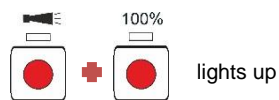

If the indicator stock is depleted, the **100%** and **Alarm** keys light up, the interval operation is stopped, and the error is recorded in the history. The alarm relay switches and reports the error to the master controller.

- When the bottle has been replaced, press **100%** key for more than one second. This also clears the alarm.

Correct water level in the measuring chamber

Indicator quantity and water quantity must be correct. Otherwise, it will result in incorrect measurements.

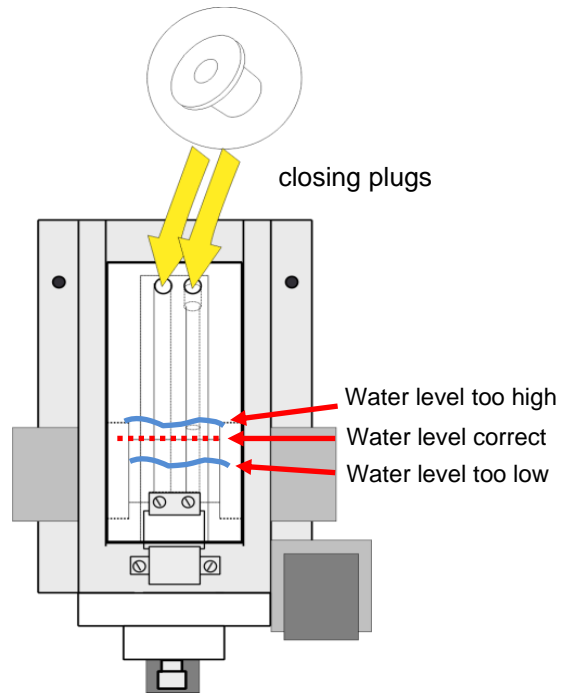

Maintenance message

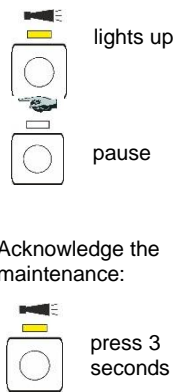

If the LED above the **Alarm** key lights up yellow, maintenance carried out by a service technician is required. The interval operation is continued. The respective message is recorded on the SD card. The alarm relay does not switch.

The service technician determines which maintenance work has to be performed by using a computer at the USB interface and then performs the maintenance work.

When this has been completed, he or she acknowledges the maintenance message by pressing the **Alarm** key for 3 seconds. Now, he or she presses the **Manual** key and the device returns to the interval operation.

Maintenance message	Description	Reaction of the device	Measures
13 Service exceeded	The maintenance interval set by the user has been exceeded. The device must undergo maintenance.	Interval operation is continued	After you have performed the maintenance, acknowledge the maintenance message. A new maintenance interval is started.

Alarm and maintenance at the same time

If an alarm and maintenance work are both pending at the same time, the **Alarm** key lights up red (for alarm) and the yellow LED lights up above the key (for maintenance).

NOTE

Maintenance

NOTE

Required maintenance measures

- Regular maintenance is necessary to ensure trouble-free operation of the instrument!



CAUTION

Cleaning measures

- Never use other solvents than isopropanol to clean the measuring chamber or other plastic parts!
- Please observe the safety regulations when handling cleaning agents!
- During the course of continuous operation, a coloured film may form on the sight-glass windows. This firmly adhering film can be easily removed using isopropanol.
- Regularly check the sight-glass windows. For difficult water types, the films must be removed from the sight-glass windows every 1 to 2 weeks in order to prevent measurement disruptions.

Cleaning intervals

Maintenance work	Quarterly	Semi-annually	Annually	Biennially / Triennially
Cleaning sight-glass windows	X			
Cleaning measuring chamber / measuring chamber holder	X			
Cleaning the receiver optics		X		
Cleaning the controller/filter housing		X		
Cleaning the waste water line	X			
Checking the dosing pump incl. suction and pressure hoses		X		
Checking electrical and hydraulic connections		X		
Renewing the sealing kit (40124) and sight-glass windows			X	
Recommendation: Allow the manufacturer to overhaul the dosing pump				X

Service instructions

The surface of the instrument has not been treated. Therefore, soiling caused by indicators, oil or grease should be avoided. However, if the housing becomes soiled, please clean the surface with isopropanol (never use other solvents).

Cleaning of the measuring chamber and the sight-glass windows

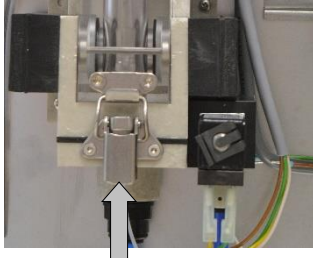

①

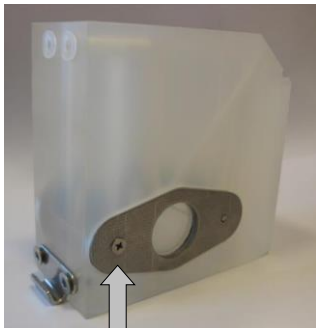

②

- Switch off the device or press the **Manual** key to interrupt measuring mode and put the device in standby mode. If a measurement is currently being carried out, wait until the measurement has been completed.
- Check that the measuring chamber is completely emptied.
- Connect the manual valve of the secondary line to the Testomat® Modul TH-R.
- Release the spring lock ①, tilt the measuring chamber upwards and take it out.
- Remove both the sight-glass holders ② and then remove the sight-glass windows for cleaning.
- Remove the film on the sight-glass windows with isopropanol.
- Clean the measuring chamber with 10 percent hydrochloric acid and then rinse it thoroughly.
- Reinsert the sight-glass windows after cleaning and fix them in place with the sight-glass holders ②.
- Insert the O-ring seals and be careful to ensure correct fitting in the groove.
- Put the measuring chamber back in place by tilting the unit and secure it with the spring lock.

Cleaning the filter housing

- Connect the manual valve of the secondary line to the Testomat® Modul TH-R.
- Press the **Manual** key and wait until the current measurement has finished. If a measurement is currently being carried out, wait until the measurement has been completed.
- Switch off the device.
- Remove the hose connections on the filter housing.
- Unscrew the supply nozzles.
- Remove and clean the seal, spring and filter.
- Remove the retaining pin and pull it out of the flow controller.
- Remove the flow controller valve body.
- Clean the filter housing with water or alcohol and reconstruct it. Ensure that you insert the filter sieve with the top facing down!
- Attach the hose connections to the filter housing.

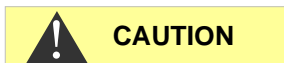
**CAUTION**

Observe the following during maintenance measures

Water ingress at the sealing points may lead to the device components being damaged!

Controller / Filter receiver complete (article no. 40125) consisting of:

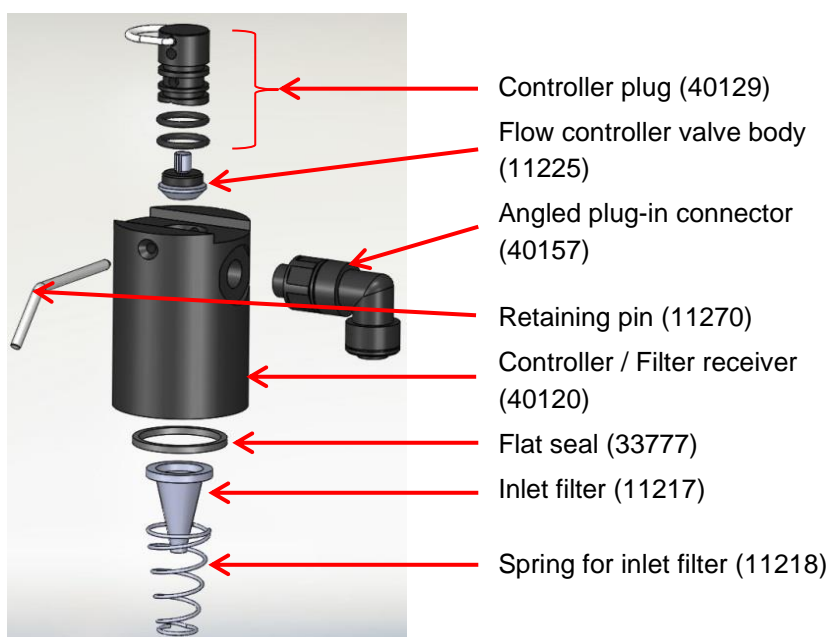

Changing an empty indicator bottle

Replace an indicator bottle, as described under section [Inserting the indicator bottle](#) on page 18.

Set the indicator reservoir to 100% again.

- Press the **100%** function key and keep it pressed down. The key that lights up when there is a shortage of indicator goes out after 1 sec.

When the yellow LED lights up, the indicator reservoir is set to 100%. The yellow LED goes out again after releasing the key.

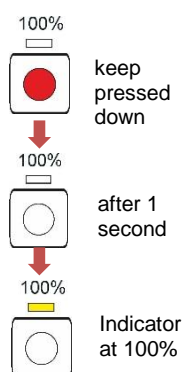

Replacing an indicator bottle without a shortage notification

You can also replace the indicator bottles, if a storage message has not yet appeared, e.g. if the indicator reservoir is low or the indicator's expiry date has been exceeded.

Replace an indicator bottle, as described under section [Inserting the indicator bottle](#) on page 18.

Set the indicator reservoir to 100% again.

- Press the **100%** function key and keep it pressed down until the yellow LED above it lights up.

The indicator reservoir has been set to 100%.

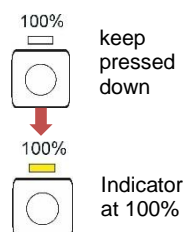

Firmware update

- Download the new firmware for the Testomat® Modul TH-R from the Heyl website download pages (www.heylanalysis.de).
- Save the new firmware in the SD card's root directory.
- Insert the SD card into the device.
- Keep the BOOT key pressed down.
- Briefly press the RESET key.

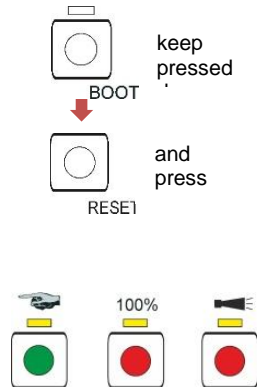

The firmware update starts. During the firmware update, the red LED lights up next to the SD card plug-in slot (indicates that the bootloader is active).

Initially, only the **Manual** function key flashes green every 2 seconds and then lights up permanently, whereupon the next LED begins flashing. The process repeats until the three function keys and the LEDs above them light up simultaneously, and then go out.

The firmware update is now complete. The device starts automatically with the new operating software. The complete firmware update takes approx. 1 minute.

Then, check the settings you configured with the Service Monitor program.

Firmware update error list

NOTE

Is there a firmware update error?

These errors can be distinguished by the red LED next to the SD card:

- If the LED lights up, the bootloader is active, and the error concerned occurred during the firmware update.
- If the LED is inactive, it is an error after the self-test.



The error category is based on the number of simultaneously flashing LEDs and function keys on the control circuit board.

- **5 LEDs flash quickly:** SD card cannot be read. Replace the SD card. If the attempted replacement fails, there is a defect on the control circuit board. Contact your service technician or the support team, the device needs to be repaired.
- **3 or 4 LEDs flash quickly:** Defect on the control circuit board. Contact your service technician or the support team, as the device needs to be repaired.
- **2 LEDs flash quickly:** The file for the firmware update was found but is invalid or defective. Download the file again (www.heylanalysis.de).
- **1 LED flashes quickly:** Problem with SD card (write protection, formatting).
- For the Testomat® Modul TH-R, the filename should correspond to the following format: "283-001.UPD", where "001" is the version

number, which increases incrementally as new versions are released.

- **LEDs do not light up one after another:** The sequence is interrupted and starts from the beginning: This means that during the programming, an error was detected, and an attempt was made to resolve the error by repeating the update process. The entire programming process is repeated up to five times. For each repeat, the entire programming process is relaunched from the start. If, after five attempts, it is still impossible to carry out a successful update, the LEDs show an error matching the previous description. The device or the control circuit board requires repair. Also send – particularly in this case – the content of the log file on the SD card "update.txt" with the item or enclose the SD card with the device.
- In normal circumstances, a firmware update is completed within approx. 1 minute.

SD card defective or full (SD Card fault)

If this error occurs, the **Alarm** function key lights up. The alarm relay switches. Measurements are continued.

- Check the SD card and replace it if required.

Optional display for measured value display



NOTE

Description

A display module can also be plugged onto the control board for the measured value display (see [Additional accessories](#) on page 51). The programming menu cannot be called up via the display. It is only designed for the measured value display. Use the Service Monitor to program the device. (see [The Service Monitor program](#) on page 27).

Risk of damage to the display

Only plug the display onto the control board for long-term use. Repeated plugging and unplugging can cause damage to the contacts, resulting in display failure. Disregard will result in the termination of the warranty service.

Installation

- Switch the device off.
- Carefully plug the display into the designated slot on the main board (see [Functions of the operating and display elements](#) on page 20).
Make sure that all contacts click into place properly.

Notes on operation

When the device is switched on with the display plugged in, the installed software version is displayed during the boot process. This allows you to visually check the current software version after a software update.

After a measurement has been completed, the measurement result is shown in the selected display unit. The display value is retained until the end of the next measurement and is then updated to the new measured value.

If a fault occurs during the last measurement, the display shows "x x x x selected display unit". If it is a temporary fault, the Alarm function key flashes at the same time (see [Temporary faults](#) on page 38). In this case, the device will start a new measurement once the programmed analysis interval has expired.

If the error is still present, the indication on the display remains and the Alarm function key remains illuminated. In this case, no further measurements are made during programmed analysis interval and the device switches to standby mode. If the fault is no longer present, the measurement result is shown on the display once the measurement has been completed and the device switches back to normal operating mode.



If a display is mounted and the service monitor is used, status messages will appear in the display.

Status message	Description
Communication PC <-> Testo module	Connection successful
Import OK	Successful import of data from the device to the service monitor
Export OK	Successful export of data from the service monitor to the device
Set date and time OK	Date and time sent from the service monitor to the device

Testomat® Modul TH-R spare parts and accessories

Caution!

Should you send your Testomat® Modul TH-R in for maintenance, please make sure that the measuring chamber has been emptied and the reagent bottles have been removed from the device. In addition, rinse the DOSIClip pump with water to remove residual indicator.

Art. no.	Pressure controller
40125	Controller / Filter receiver, complete
40120	Controller / Filter receiver
40129	Controller plug T2000, complete
11225	Flow controller valve body
11270	Retaining pin 3x50 / 135 degree
11217	Inlet filter 19,5dx25
11218	Spring for inlet filter
40121	Inlet connector
40153	Screw-in connector G 1/4"
40150	Screw-in connector G 1/8"
Measuring chamber	
40173	Sight-glass window with seal
40170	Sight-glass window 30x3
40176	Sight-glass holder
33253	Bolt M3x40, A2, DIN 965
40032	Latch fastener TL-17-201-52
11210	Plug for measuring chamber
40022	Measuring chamber T2000 complete.
Measuring chamber holder	
40029	Measuring chamber holder Testomat® Modul TH-R
40050	Magnetic stirrer
40156	Screw-in connector 3/8" -10
40056	Solenoid valve, 2/2-way, Testomat® ECO
Dosing pump DOSIClip®	
270470	Dosing pump DOSIClip
Bottle connection/Suction device	
40131	Screw cap with insert for 500 ml bottle
Instrument spare parts	
31271	Fuse G-M, 5x20mm, M 1 A
37896	Base circuit board Testomat® Modul TH-R
37805	Control circuit board Testomat® Modul TH-R
37734	Cable gland M16 x 1,5
37735	Nut M16x1,5 for cable gland
37832	Ribbon cable 2 x 7 pole
40060	Cable loom 2V for T2000
40062	Cable loom 2P for T2000
32187	Outlet funnel with snap lug
37774	Spacer ring for drain funnel
37798	Cover

Art. no.	Installation
40153	Inlet for Testomat® Modul TH-R D=6
37581	Pipe, PE, D=6 d=4 L=5 m (5 m supply hose with 6 mm external diameter)
35715	Outlet hose 12 x 15 x 2000 mm (2 m outlet hose with 12 mm internal diameter)

Indicators

Indicator type	Range	Quantity	Art. No.:
TH2005	Water hardness 0.05 - 0.5 °dH	500 ml	152005
TH2025	Water hardness 0.25 - 2.5 °dH	500 ml	152025
TH2050	Water hardness 0.5 – 5.0 °dH	500 ml	152050
TH2100	Water hardness 1.0 - 10.0 °dH	500 ml	152100
TH2250	Water hardness 2.5 - 25.0 °dH	500 ml	152250

Additional accessories

Art. No.	Designation
040187	Connector set: Cock, hoses, reducers
130010	Mini irrigator type R for Testomat devices
270357	Service set Testomat Modul TH-R including flow controller valve body
270360	1-Year service set
270410	MepuClip booster pump
100490	Standard SD card
040123	Conversion kit for water intake *)
37764	OLED display module, pluggable, complete

***) Conversion kit for water intake, Art. No. 040123**

When using fabric pressure hoses (e.g. for existing installations), please replace the plug connection on the controller and filter housing for a plug for the quick-release coupling (not included in the delivery scope).

A current device overview of the available accessories can be found in details in our delivery scope in the download section of our website (www.heylanalysis.de).

Technical data

Power supply:	24 VDC The device is protected against reverse polarity.
Power consumption:	max. 1 A, without external load
Protection class:	I
Degree of protection:	IP 43 (with cover), IP 40 (without cover)
Conformity:	EN 61326-1, EN 61010-1 BS EN IEC 61326-1, BS EN 61010-1+A1
Ambient temperature:	10 - 40 °C
Measuring range:	See section Performance specifications on page 10
Current interface:	max. load 500 Ohms
USB device interface:	Type Mini-B (connector); USB 2.0 Full speed
SD Card:	SD or SDHC cards with a maximum capacity of 32GByte are suitable. The card must be FAT or FAT32 formatted.
Relay contact load:	max. 35 VAC / 60 VDC; max. 4 A
Battery:	Lithium CR2032
Dimensions:	W x H x D = 270 x 350 x 147 mm
Weight::	with cover: 5300 g without cover 4350 g



Water connection	
Operating pressure:	1 to 8 bar / 1×10^5 to 8×10^5 Pa or 0.3* to 1 bar / 0.3×10^5 to 1×10^5 Pa (Remove flow controller valve body 11225!)
Water inlet:	Opaque pressure hose with external diameter 6 mm
Water outlet:	Hose with internal diameter 12 mm
Water temperature:	10 - 40 °C

We reserve the right to make technical changes without notice in the interest of constantly improving our products!

Conformity Declaration



EC Conformity Declaration



for the following product

Testomat® Modul TH-R

Measuring converter for residual total hardness (water hardness) parameterisable via RS232

We hereby confirm that the above product conforms to the principal health and safety regulations laid down in the EC Directives 2014/30/EU and 2014/35/EU.

This declaration applies to all units produced in accordance with the attached manufacturing documents which are a constituent part of this declaration.

The product was assessed with reference to the following standards:



EN 61326-1: Electrical equipment for measurement, control and laboratory use - EMC requirements

EN 61010-1: Safety requirements for electrical equipment for measurement, control and laboratory use



BS EN IEC 61326-1 Electrical equipment for measurement, control and laboratory use. EMC requirements. General requirements

BS EN 61010-1+A1 Safety requirements for electrical equipment for measurement, control, and laboratory use. General requirements

This declaration is made on behalf of

**GEBRÜDER HEYL
Analysentechnik GmbH & Co. KG
Orleansstraße 75b
31135 Hildesheim**

by

Jörg-Tilman Heyl

General Manager

Hildesheim, 22/11/2021

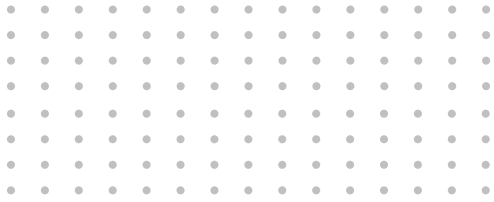

Gebrüder Heyl
Analysentechnik GmbH & Co. KG
Orleansstraße 75b
D 31135 Hildesheim
www.heylandanalysis.de

Testomat-Modul_TH-R_EN_230330



Scan the code and
visit us on our website!